

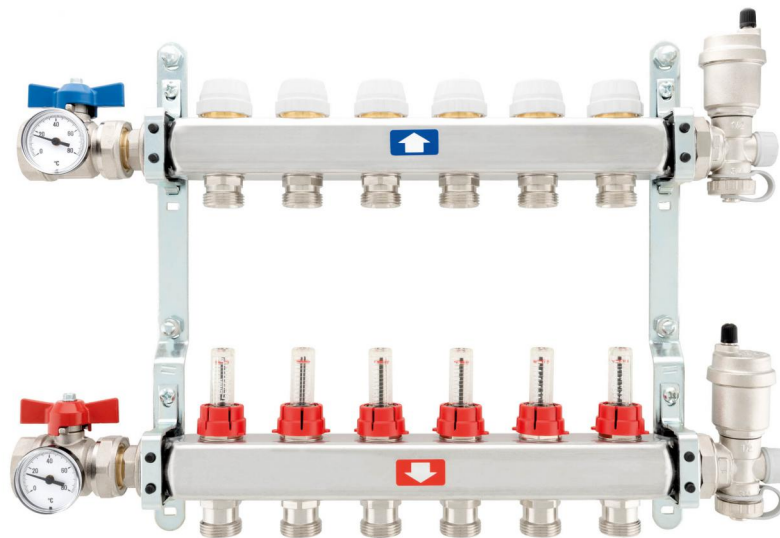

TECHNICAL CATALOGUE

PRE-ASSEMBLED STAINLESS STEEL MANIFOLDS



> THE COMPANY

ITAP SpA, founded in Lumezzane (Brescia) in 1972, is currently one of the leading production companies in Italy of **valves, fittings and distribution manifolds** for plumbing and heating systems.

Thanks to fully automated production processes, with 87 transfer machines and 70 assembly lines, we are able to produce 400,000 pieces per day.

Our innate pursuit for innovation and observance of technical regulations is supported by the company certification ISO 9001. The company has always considered its focus on quality as the main tool to obtain significant business results: today ITAP SpA is proud to offer products bearing the approval of numerous international certifying bodies.

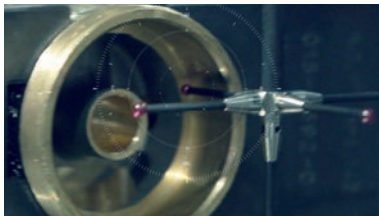
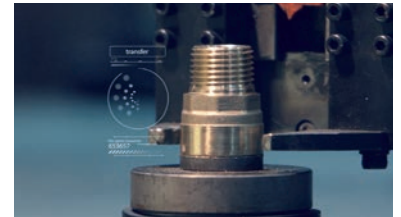
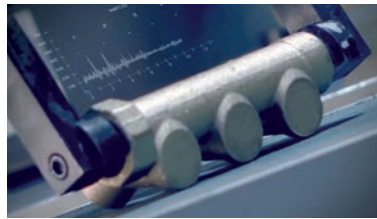
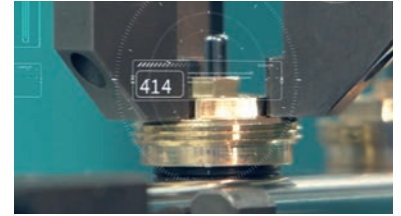
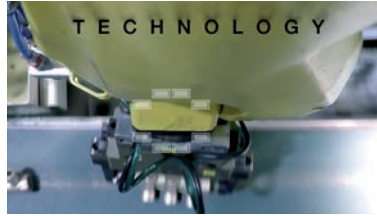

> ITAP products have obtained approvals by more than 30 certification bodies from all over the world.





PRE-ASSEMBLED STAINLESS STEEL MANIFOLDS

907C Complete pre-assembled manifold, with flow meters

100% TESTED



SIZE	PRESSURE	CODE	PACKING
1"x3/4"x2	6bar/87psi	9070010002034C	1/1
1"x3/4"x3	6bar/87psi	9070010003034C	1/1
1"x3/4"x4	6bar/87psi	9070010004034C	1/1
1"x3/4"x5	6bar/87psi	9070010005034C	1/1
1"x3/4"x6	6bar/87psi	9070010006034C	1/1
1"x3/4"x7	6bar/87psi	9070010007034C	1/1
1"x3/4"x8	6bar/87psi	9070010008034C	1/1
1"x3/4"x9	6bar/87psi	9070010009034C	1/1
1"x3/4"x10	6bar/87psi	9070010010034C	1/1
1"x3/4"x11	6bar/87psi	9070010011034C	1/1
1"x3/4"x12	6bar/87psi	9070010012034C	1/1
1"x3/4"x13	6bar/87psi	9070010013034C	1/1

CERTIFICATIONS



TECHNICAL SPECIFICATIONS

Consisting of:

- 1 return manifold in stainless steel AISI 304L with shut-off valves preset for electrothermal actuators
- 1 flow manifold in stainless steel AISI 304L with flow meters
- 2 complete metal brackets
- 2 shut-off ball valves with thermometers
- 2 end pieces with air vent valve and drain cock
- Available on demand with deeper mounting brackets art. 498ST without extra-charge

Available sizes: 1".

Maximum working pressure: 6 bar (10 bar for installation test).

Maximum working temperature: 70°C

Threads: ISO 228 (equivalent to DIN EN ISO 228 and BS EN ISO 228).

Outlets: from 2 to 13, 3/4" Eurokonus.

Outlet centre distance: mm.50.

In case of use of electric actuators Art. 891M and 891MR, it is suggested to use the off-centre by-pass kit Art. 860BY.

ATTENTION: manifolds will be supplied mounted on the brackets; accessories will be supplied separately, inside the same box.



PRE-ASSEMBLED STAINLESS STEEL MANIFOLDS

OVERALL DIMENSIONS

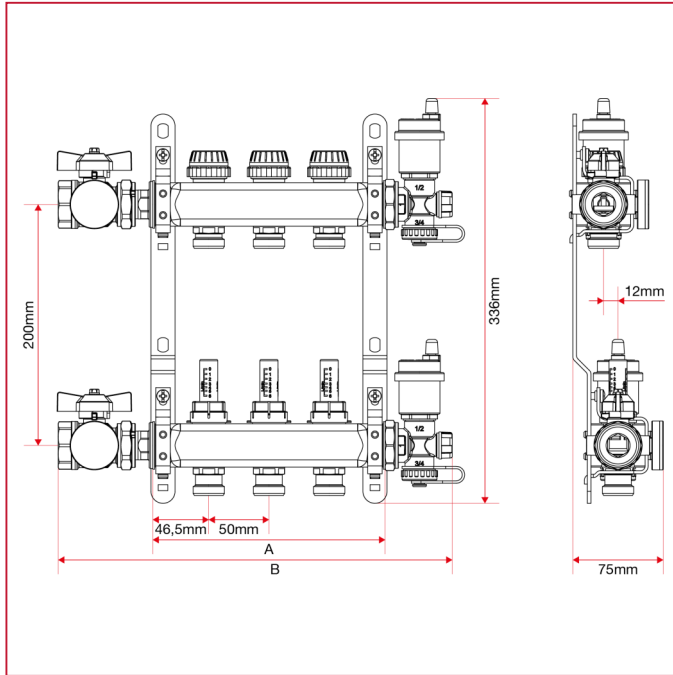

	1"x3/4"x 2	1"x3/4"x 3	1"x3/4"x 4	1"x3/4"x 5	1"x3/4"x 6	1"x3/4"x 7	1"x3/4"x 8	1"x3/4"x 9	1"x3/4"x 10	1"x3/4"x 11	1"x3/4"x 12	1"x3/4"x 13
A	143	193	243	293	343	393	443	493	543	593	643	693
B	277	327	377	427	477	527	577	627	677	727	777	827
Kg/cm² bar	6	6	6	6	6	6	6	6	6	6	6	6
LBS - psi	87	87	87	87	87	87	87	87	87	87	87	87



PRE-ASSEMBLED STAINLESS STEEL MANIFOLDS

MATERIALS

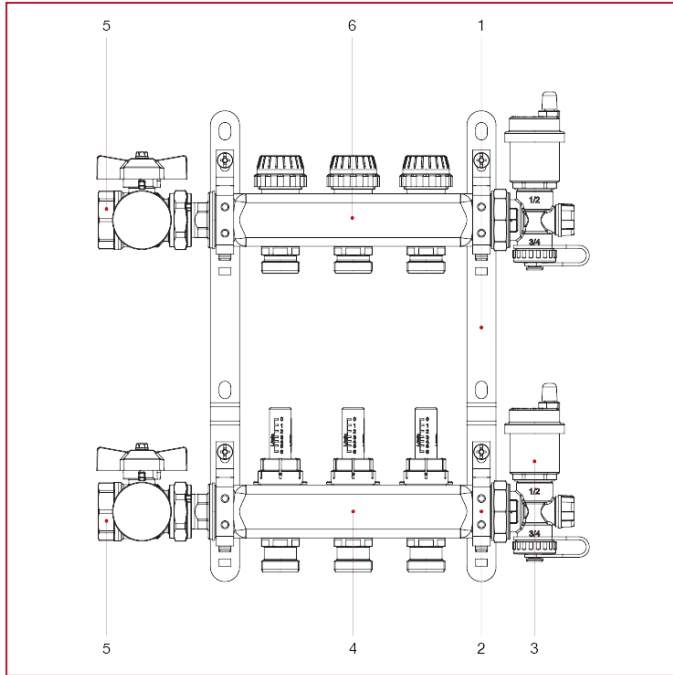

POS.	DESCRIPTION	N.	MATERIAL
1	Mounted bracket in steel	2	Steel P11
2	Mounted collar	4	Steel P11
3	Automatic air vent group	2	Nickel-plated brass CW617N
4	Single manifold in stainless with flow meters	1	Stainless steel AISI 304L
5	IDEAL ball valve kit for manifolds	1	Nickel-plated brass CW617N
6	Single manifold in stainless steel with shut-off valves	1	Stainless steel AISI 304L



PRE-ASSEMBLED STAINLESS STEEL MANIFOLDS

INSTRUCTIONS ON INSTALLATION, USE AND MAINTENANCE

Technical specifications:

Available sizes: 1"

Maximum operating pressure with installed flow meters: 6 bar (10 bar for installation test)

Maximum operating pressure with installed lockshields: 10 bar

Maximum working temperature: 70°C (with flow meters), 80°C (with lockshields).

Threads: ISO 228 (equivalent to DIN EN ISO 228 and BS EN ISO 228).

Outlets: from 3 to 13, 3/4" Eurokonus.

Outlet centre distance: mm.50

POSITIONING THE STAINLESS STEEL MANIFOLDS INTO METAL BOXES

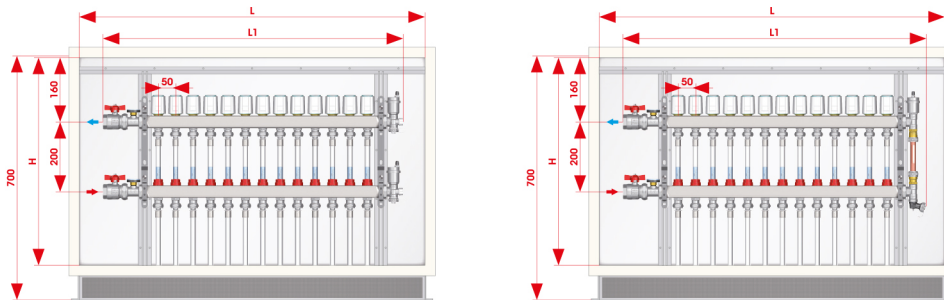

CODICE / CODE / CODE / CÓDIGO / TEILENUMMER / КОД	498.500.600	498.600.600	498.700.600	498.800.600	498.1000.600
L x H (mm)	500x600	600x600	700x600	800x600	1000x600
N° vie / outlet / voies / vías / Wege / ходов	3-4	5-6	7-8	9-10	11-12-13
COLLETTORE / MANIFOLD / COLLECTEUR / COLECTOR / VERTEILER / КОЛЛЕКТОР	1"				
L1	386	486	586	686	836

HOW TO ADJUST THE FLOW RATE

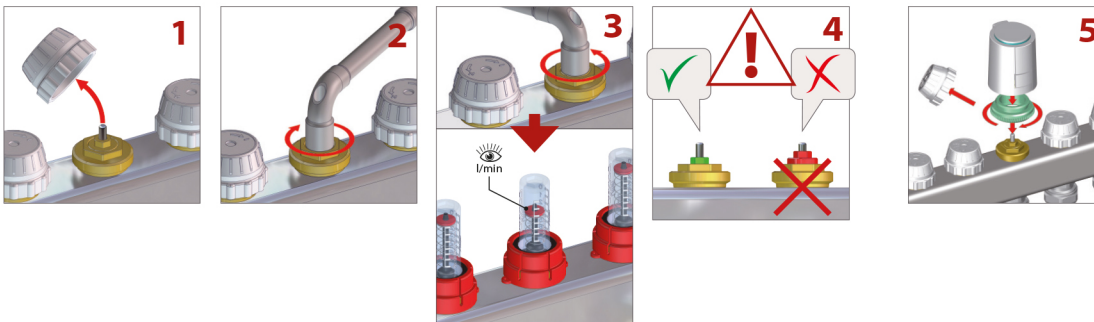

1. Remove the plastic cap from the valve, installed on return manifold.
2. The valve, equipped with a pre-setting insert, is normally supplied with the spindle completely open. Please, close each valve by means of a 8 mm key tool, by turning the insert clockwise.
3. Adjust the flow rate of each circuit by turning the insert anti-clockwise till you read, on the flowmeter installed on the flow manifold, the required flow rate.
4. The fine thread of the pre-setting valve must not be seen above the edge of its hexagonal seat: the insert is totally open (full flow) when you have turned it anti-clockwise at approximately 2.5 turns.
5. Once you have adjusted the flow rate, the valve has to be protected from dust and dirt by screwing back the plastic cap of by installing an electrothermal actuator.

FLOWMETER ADJUSTMENT



PRE-ASSEMBLED STAINLESS STEEL MANIFOLDS

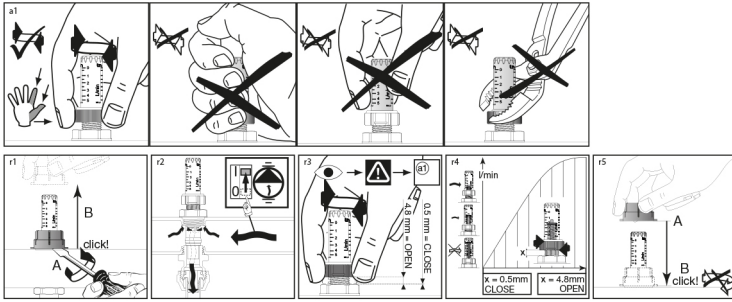

- The pre-setting valve works as a regular valve (ON-OFF operation), if it is used in its totally open position.

LOCKSHIELD ADJUSTMENT

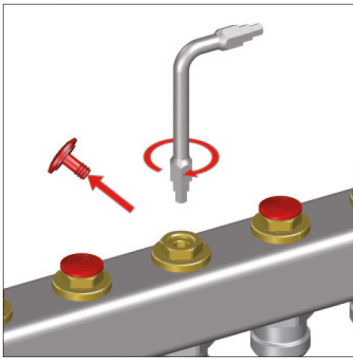

- Starting from a totally closed position, open the lockshield according to the enclosed chart, in order to achieve the desired flow rate. The adjustment has to be done by means of a hexagonal key in the size of 6 mm

SETTING TURNS AND FLOW RATE DIAGRAM

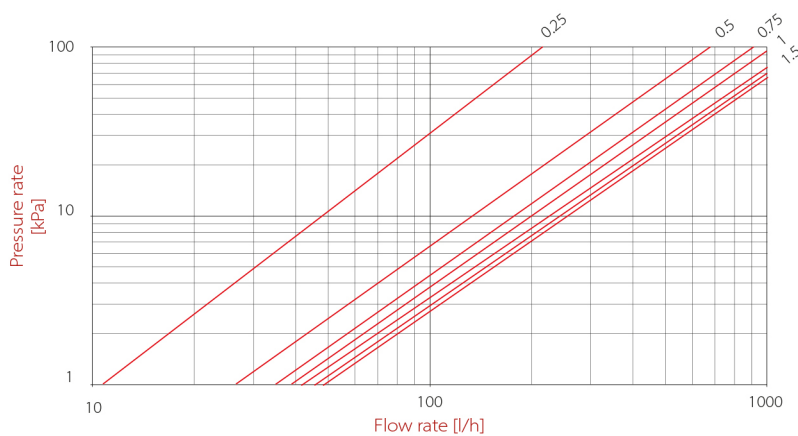

REGOLAZIONE (giri) - REGULATION (rpm) - RÉGLAGE (tours) - REGULACION (revoluciones) - EINSTELLUNG (Umdrehungen) - Регулировка (обороты)	0.25	0.5	0.75	1	1.5	2	2.5
Kv	0.22	0.68	0.91	1.05	1.22	1.30	1.35

TECHNICAL NOTE:

In case of installation of manifolds equipped with pre-setting valves, the flowmeter has not to be used as a balancing valve, but



PRE-ASSEMBLED STAINLESS STEEL MANIFOLDS

just to read the required flow rate. In any case, if you prefer to balance the flow rate by means of flowmeter, this is possible also in case of use of a pre-setting valve. In fact, as it is supplied in its totally open position, you can adjust the flow rate of each circuit as usual (please, see the following specification), by turning the flowmeter and leaving pre-setting valve completely open.

DIAGRAMS

- Below are the flow rate / pressure drop diagrams relative to pre-assembled manifolds with main 1" connections.

Diagram of flow meter fully open (flow manifold)

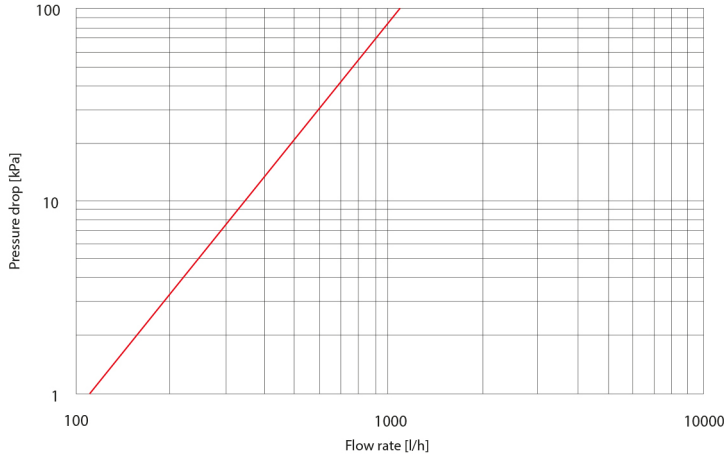

$K_v = 1,1 \text{ m}^3/\text{h}$

Regulation lockshield diagram (flow manifold)

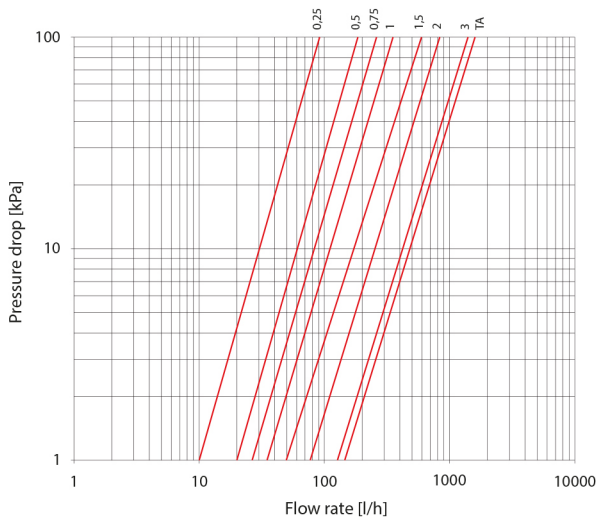

Regolazione (giri) Regulation (rpm) Réglage (tours) Regulación (revoluciones) Einstellung (Umdrehungen) Регулировка (обороты)	K_v [m^3/h]
0,25	0,09
0,5	0,19
0,75	0,27
1	0,36
1,5	0,60
2	0,83
3	1,45
TA (open - Vollöffnung - открыто)	1,65



ITAP SpA reserves the right to change the products and their relevant technical data at any time and without prior notice.

