

# TACOSSETTER BYPASS 100

## BALANCING VALVE

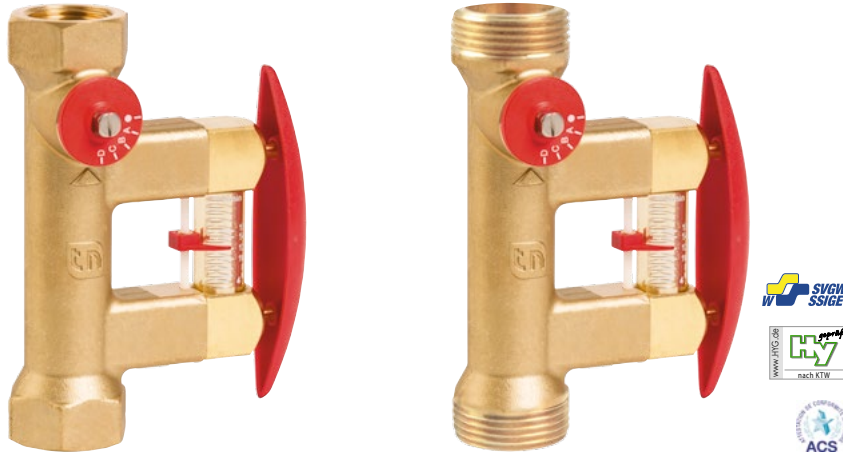

### ADVANTAGES

- Accurate and fast adjustment with scale and without the aid of diagrams, tables or measurement devices
- Direct reading of the set volume flow in l/min
- Variable installation position, maintenance-free
- Flow control with setpoint adjuster
- Regulating valve with isolating facility (rest leakage possible)
- Minimal pressure loss

Direct regulation, indication and isolation of flows in systems.

### DESCRIPTION

Direct hydraulic balancing and control of flows to consumers or in a subsystem. Balancing valves offer an easy and accurate method of adjusting the flow rates for heating-, ventilation-, air conditioning- and cooling systems.

Correct balancing of hydraulic circuits ensures optimum energy distribution, resulting in more efficient and economical operation in accordance with the energy saving regulations provided for by legislation.

With TacoSetter Bypass balancing valves, any qualified fitter can set the appropriate flow rate using the unique flow measurement device, avoiding investments in training and costly measuring devices.

### INSTALLATION POSITION

The TacoSetter Bypass 100 requires a straight section of pipe of the same length and diameter as the system. The valve can be installed in a horizontal, vertical or inclined position. Care should be taken that the arrow is pointing in the direction of the flow.

### OPERATION

The flow measurement is based on the principle of a baffle float with return spring. The reading position is the bottom line of the baffle float. The measuring device is placed in a bypass to the main flow, isolated from system flow. By demand the bypass, with self locking valves, gets opened / closed by pressing / releasing the clamp. Reading the flow rate has no influence on the main flow rate.

### BUILDING CATEGORIES

For pipe installations in drinking water, heating and cooling area:

- Apartment blocks, housing estates, multiple dwelling units
- Residential care facilities, hospitals
- Administration and service buildings
- Hotels and restaurants, industrial kitchens
- School buildings and sports facilities
- Commercial and industrial buildings
- Facilities with partial use, such as barracks, camping sites

### SYSTEM/BASIC DIAGRAM

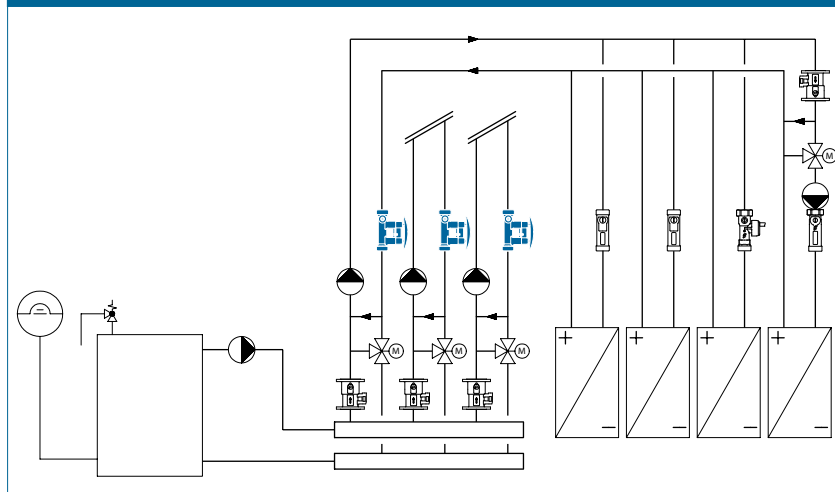

# TACOSSETTER BYPASS 100 | BALANCING VALVE

## SPECIFICATION TEXT

See [www.taconova.com](http://www.taconova.com)

## TECHNICAL DATA

### General

- Operating temperature  $T_{0 \text{ max}}$ : 100 °C
- Operating pressure  $P_{0 \text{ max}}$ : 10 bar
- Measuring accuracy:
  - Measurement range 20 – 80%:  $\pm 5\%$  of the indicated value
  - Measurement range <20% / >80%:  $\pm 10\%$  of the indicated value
- $k_{VS}$  value and measurement range see «Type overview»
- Female thread (cylindrical) to DIN 2999 / ISO 7 or male thread G (cylindrical) to ISO 228

### Material

- Housing: brass
- Inside: stainless steel, brass, plastic
- Sight glass: heat- and impact resistant plastic
- Seals: EPDM

### Fluids

- Heating water (VDI 2035; SIA Directive 384/1; ÖNORM H 5195–1)
- Cooling water (DIN 1988-7)
- Potable water (with SVGW-certificate)
- Water and proprietary additives used against corrosion and freezing (see document «Correction curves»)

## APPROVALS / CERTIFICATES

- SVGW, ACS, KTW

## ADDITIONAL MODELS

Setter for solar applications, see data sheets TacoSetter Bypass Solar 130 and TacoSetter Bypass Solar 185. Complete sets with insulation box are available for the TacoSetter Bypass 100 (see our „Range of Products“ catalog and our „Price List“).

## GLYCOL CORRECTION CURVES

There is a separate diagram for TacoSetter up to DN25 and its flow ranges with nine correction curves for use of anti-frost and anti-corrosion agents. Corrections are not required for larger dimensions as the deviation lies within the measuring tolerance. See [www.taconova.com](http://www.taconova.com)

## TYPE OVERVIEW

TacoSetter Bypass 100 | Balancing valve with female thread

Order no.	DN	Rp × Rp	Measuring range	$k_{VS}$ (m <sup>3</sup> /h)
223.2262.000	15	½" × ½"	2 – 8 (l/min)	1,95
223.2361.000	20	¾" × ¾"	2 – 8 (l/min)	1,95
223.2360.000	20	¾" × ¾"	4 – 15 (l/min)	3,3
223.2362.000	20	¾" × ¾"	8 – 30 (l/min)	5,0
223.2460.000	25	1" × 1"	6 – 20 (l/min)	5,1
223.2461.000	25	1" × 1"	10 – 40 (l/min)	8,1
223.2561.000	32	1 ¼" × 1 ¼"	20 – 70 (l/min)	17,0
223.2661.000	40	1 ½" × 1 ½"	30 – 120 (l/min)	30,0
223.2861.000	50	2" × 2"	50 – 200 (l/min)	54,0

TacoSetter Bypass 100 | Balancing valve with male thread

Order no.	DN	G × G	Measuring range	$k_{VS}$ (m <sup>3</sup> /h)
223.2272.000	20	1" × 1"	2 – 8 (l/min)	2,2
223.2370.000	20	1" × 1"	4 – 15 (l/min)	3,3
223.2372.000	20	1" × 1"	8 – 30 (l/min)	5,0
223.2470.000	25	1 ¼" × 1 ¼"	6 – 20 (l/min)	5,1
223.2471.000	25	1 ¼" × 1 ¼"	10 – 40 (l/min)	8,1
223.2571.000	32	1 ½" × 1 ½"	20 – 70 (l/min)	17,0

## DIMENSIONAL DRAWING

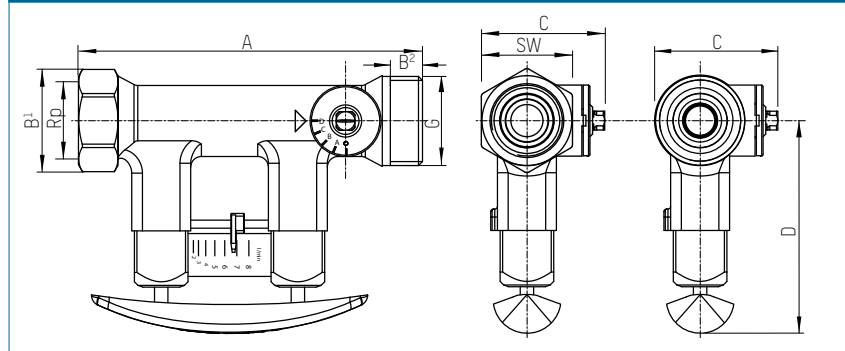

## MEASUREMENT TABLE

TacoSetter Bypass 100 | Balancing valve with female thread

Order no.	DN	A	B <sup>1</sup>	C	D	SW	Rp
223.2262.000	15	142	39	46	79	34	½"
223.2361.000	20	129	39	46	79	34	¾"
223.2360.000	20	129	39	46	79	34	¾"
223.2362.000	20	129	39	46	79	34	¾"
223.2460.000	25	152	47	58	82	41	1"
223.2461.000	25	152	47	58	82	41	1"
223.2561.000	32	161	56	65	84	49	1 ¼"
223.2661.000	40	173	64	79	90	59	1 ½"
223.2861.000	50	197	76	91	97	70	2"

TacoSetter Bypass 100 | Balancing valve with male thread

Order no.	DN	A	B <sup>2</sup>	C	D	G
223.2272.000	20	129	12	46	79	1"
223.2370.000	20	129	12	46	79	1"
223.2372.000	20	129	12	46	79	1"
223.2470.000	25	152	15	58	82	1 ¼"
223.2471.000	25	152	15	58	82	1 ¼"
223.2571.000	32	161	15	65	84	1 ½"

# TACOSSETTER BYPASS 100 | BALANCING VALVE

## PRESSURE LOSS DIAGRAMS

223.2262.000 (DN 15 | ½" | 2...8 l/min)  
 223.2361.000 (DN 20 | ¾" | 2...8 l/min)  
 223.2272.000 (DN 20 | 1" | 2...8 l/min)

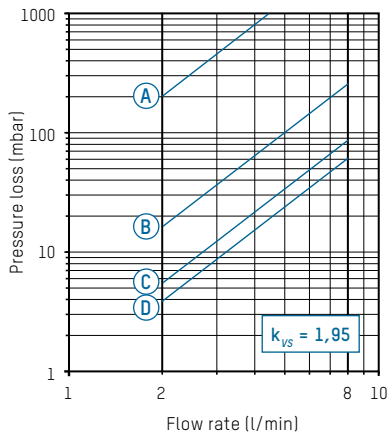

A - D Valve position

223.2360.000 (DN 20 | ¾" | 4...15 l/min)  
 223.2370.000 (DN 20 | 1" | 4...15 l/min)

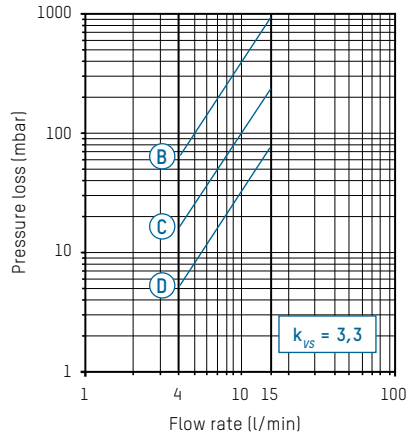

B - D Valve position

223.2362.000 (DN 20 | ¾" | 8...30 l/min)  
 223.2372.000 (DN 20 | 1" | 8...30 l/min)

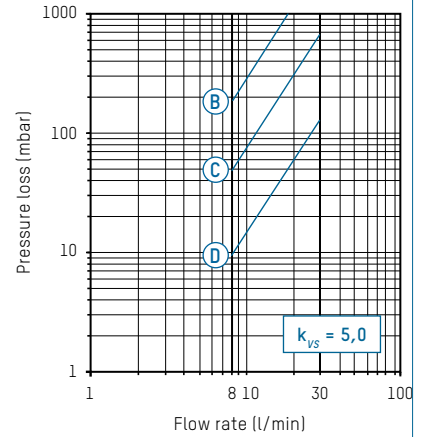

B - D Valve position

223.2460.000 (DN 25 | 1" | 6...20 l/min)  
 223.2470.000 (DN 25 | 1¼" | 6...20 l/min)

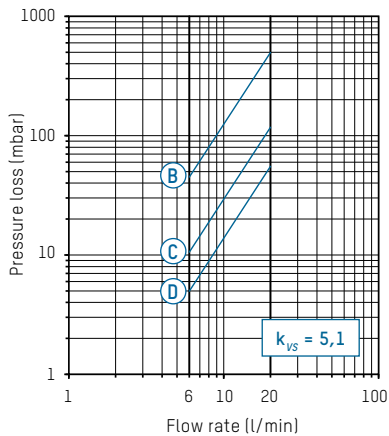

B - D Valve position

223.2461.000 (DN 25 | 1" | 10...40 l/min)  
 223.2471.000 (DN 25 | 1¼" | 10...40 l/min)

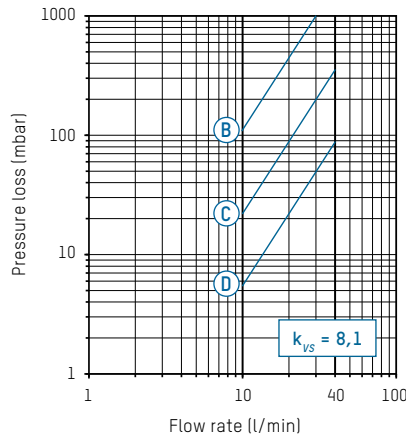

B - D Valve position

223.2561.000 (DN 32 | 1¼" | 20...70 l/min)  
 223.2571.000 (DN 32 | 1½" | 20...70 l/min)

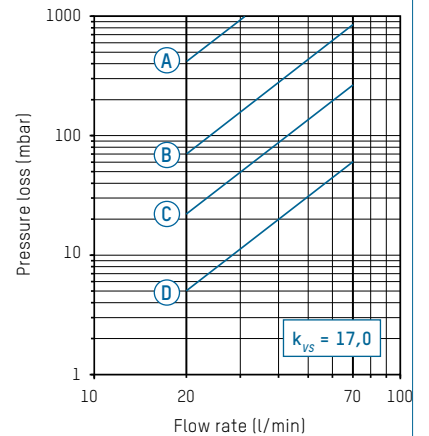

A - D Valve position

223.2661.000 (DN 40 | 1½" | 30...120 l/min)

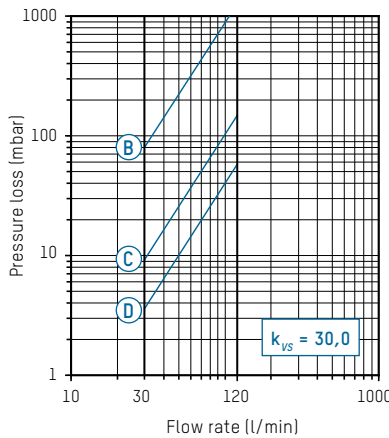

B - D Valve position

223.2861.000 (DN 50 | 2" | 50...200 l/min)

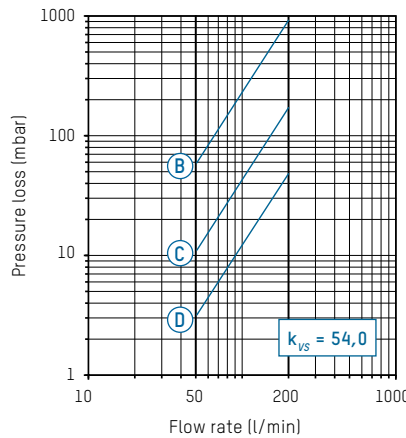

B - D Valve position

## TACOSSETTER BYPASS 100 | BALANCING VALVE

### ACCESSORIES



### INSULATION BOX

EPP, T<sub>0</sub> -30 – 130 °C, in accordance with EnEV guideline

Order no.	Fits to
296.2321.004	DN 15 + DN 20
296.2322.004	DN 25
296.2323.004	DN 32
296.2324.004	DN 40
296.2325.004	DN 50



### SYSTEM SCREW CONNECTION FITS TO TACOSSETTER BYPASS

Screw connection with male thread R (conical) as per DIN 2999

Order no.	G × R	Version for	Fits to
210.6630.000	¾" × ½"	Threaded pipe Rp ¾"	DN 15
210.6631.000	1" × ½"	Threaded pipe Rp ¾"	DN 15
210.6632.000	1" × ¾"	Threaded pipe Rp ¾"	DN 20
210.6633.000	1¼" × 1"	Threaded pipe Rp 1"	DN 25



Screw connection with solder connection

Order no.	G x mm	Version for	Fits to
210.5331.019	1" x 18	Copper pipe ø 18 mm	DN 15 (Male)
210.5332.019	1" x 22	Copper pipe ø 22 mm	DN 20 (Male)
210.5334.003	1¼" x 28	Copper pipe ø 28 mm	DN 25 (Male)

### SPARE PARTS



### SIGHT GLASS (COMPLETE) AND SEAL

Order no.	Range	Fits to
298.2333.020	2 – 8 (l/min)	223.2262.000 / 223.2272.000
298.2334.020	4 – 15 (l/min)	223.2360.000 / 223.2370.000
298.2335.020	8 – 30 (l/min)	223.2362.000 / 223.2372.000
298.2342.020	6 – 20 (l/min)	223.2460.000 / 223.2470.000
298.2343.020	10 – 40 (l/min)	223.2461.000 / 223.2471.000
298.2352.020	20 – 70 (l/min)	223.2561.000 / 223.2571.000
298.2362.020	30 – 120 (l/min)	223.2661.000
298.2382.020	50 – 200 (l/min)	223.2861.000